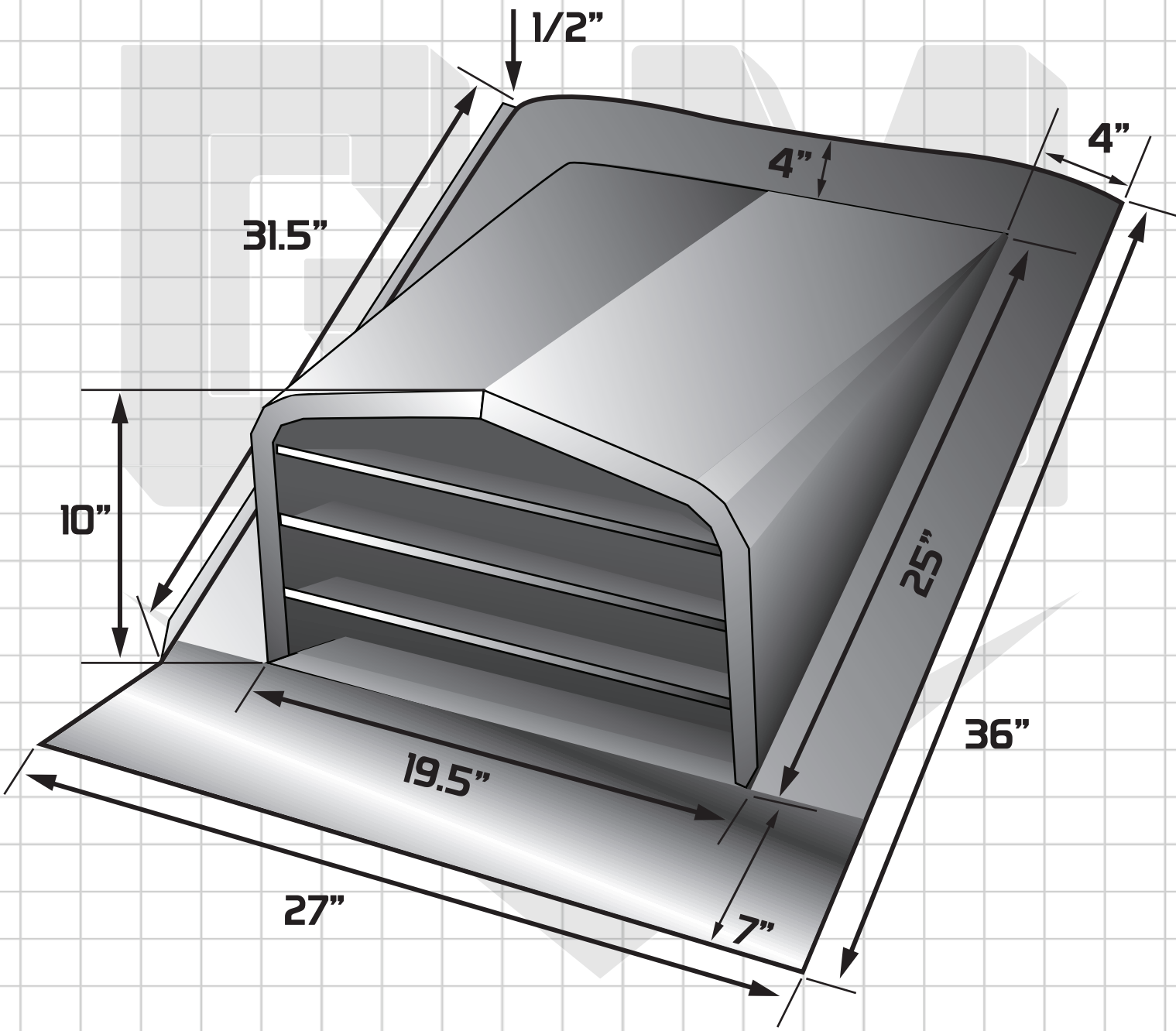

MODEL: Dormer Vent
ITEM: 4 / 12 - DVA

SUBMITTAL SHEET

GENERAL METALS MFG
 2727 W, WELDON AVE.
 PHOENIX, AZ 85017
 FAX: 602.277.6039
 PHONE: 602.264.4815
 www.generalmetals.com

NOT TO SCALE

JOB: _____
ARCHITECT: _____
ENGINEER: _____
CONTRACTOR: _____
LOCATION: _____

FREE AREA: 100 SQ. INCH

TAG	QTY			